

12.3" HD
High brightness color TFT-LCD module

Model: VM12S1 V1

Date: Mar. 29th, 2021

**Note: This specification is subject to change
without notice**

Customer : _____

Date : _____

Approved

Prepared

Date:

Date:

Contents

- 1. Handling Precautions**
- 2. General Description**
 - 2.1 Overview
 - 2.2 Features
 - 2.3 Application
 - 2.4 Display specifications
 - 2.5 Optical characteristics
- 3. Absolute Maximum Ratings**
 - 3.1 TFT LCD module
 - 3.2 Backlight unit
 - 3.3 Environment
- 4. Electrical characteristics**
 - 4.1 LCD electronics specification
 - 4.2 Backlight unit
 - 4.3 Interface connector
 - 4.3.1 TFT connector(CN1)
 - 4.3.2 Backlight connector(CN2、CN3)
- 5. Timing characteristics**
 - 5.1 LVDS AC electrical characteristics
 - 5.2 LVDS DC electrical characteristics
 - 5.3 Input clock and data timing diagram
 - 5.4 Timing
 - 5.5 Data input format
- 6. Reliability Test**
- 7. Shipping package**
- 8. Mechanical Characteristics**

RECORD OF REVISION

Version and Date	Page	Old description	New description	Remark
0.1 2021/03/29	All	First Edition for customer		

1. Handling Precautions

- 1) Since front polarizer is easily damaged, pay attention not to scratch it.
- 2) Be sure to turn off power supply when inserting or disconnecting from input connector.
- 3) Wipe off water drop immediately. Long contact with water may cause discoloration or spots.
- 4) When the panel surface is soiled, wipe it with absorbent cotton or other soft cloth.
- 5) Since the panel is made of glass, it may break or crack if dropped or bumped on hard surface.
- 6) Since CMOS LSI is used in this module, take care of static electricity and insure human earth when handling.
- 7) Do not open or modify the Module Assembly.
- 8) Do not press the reflector sheet at the back of the module to any directions.
- 9) At the insertion or removal of the Signal Interface Connector, be sure not to rotate nor tilt the Interface Connector of the TFT Module.
- 10) After installation of the TFT Module into an enclosure, do not twist nor bend the TFT Module even momentary. At designing the enclosure, it should be taken into consideration that no bending/twisting forces are applied to the TFT Module from outside. Otherwise the TFT Module may be damaged.

2. General Description

2.1 Overview

This specification applies to the Color Active Matrix Liquid Crystal Display composed of a TFT-LCD display a LED backlight system. The screen format is intended to support HD (1920(H) x720(V)) screen and 16.7M colors.

2.2 Features

- High brightness display, 1500nits by LED backlight.
- Long operation lifetime BLU design
- RoHS Compliance
- Extra wide operation temperature
- Wide view angle

2.3 Application

Industrial, automotive applications.

2.4 Display specifications

Items	Unit	Specification
Screen Diagonal	inch	12.3"
Active Area	mm	292.608 (H) X 109.728 (V)
Pixels H x V	pixels	1920 x3(RGB) x 720
Pixels Pitch	um	152.4 (per one triad) x 152.4
Pixel Arrangement		RGB Vertical stripe
Display mode		Normally black
White luminance (center)	Cd/m ²	1500 (Typ)
Contrast ratio		1000:1 (Typ.)
Optical Response Time	msec	25 ms (Typ. On/off)
Normal Input Voltage VDD	Volt	3.3
Power Consumption (Vcc Line + LED backlight)	Watt	16.698 W (VDD line=0.858 W; LED lines= 15.84 W)
Weight	Grams	463
Physical size	mm	310 (W)×129.1 (H)×7.5 (D)
Electrical Interface		LVDS
Support colors		16.7M colors
Surface Treatment		Anti-glare and hard-coating 3H
Temperature range		
Operating	°C	-30 ~ 85 (TFT surface)
Storage	°C	-40 ~ 90
RoHS Compliance		RoHS Compliance

2.5 Optical characteristics

The following optical characteristics are measured under stable condition at 25 °C

Items	Unit	Conditions	Min.	Typ.	Max.	Note
Viewing angle	Deg.	Horizontal (Right)		85		2
		CR=10 (Left)		85		
		Vertical (Up)		85		
		CR=10 (Down)		85		
Contrast Ratio		Normal Direction	700	1000		3
Response Time	msec	Raising + Falling		25		4
Color / Chromaticity Coordinates (CIE)		Red x	-0.05	0.642	+0.05	5
		Red y		0.294		
		Green x		0.274		
		Green y		0.675		
		Blue x		0.152		
		Blue y		0.068		
		White x		0.313		
		White y		0.329		
Color coordinates (CIE) White						
Center Luminance	Cd/m ²		1200	1500		6
Luminance Uniformity	%		70	75		7
Crosstalk (in 60 Hz)	%				1.5	
Flicker	dB				-20	

Note 1: Measurement method

The LCD module should be stabilized at given temperature for 0.5 hour to avoid abrupt temperature change during measuring. In order to stabilize the luminance, the measurement should be executed after lighting Backlight for 1 hour in a windless room.

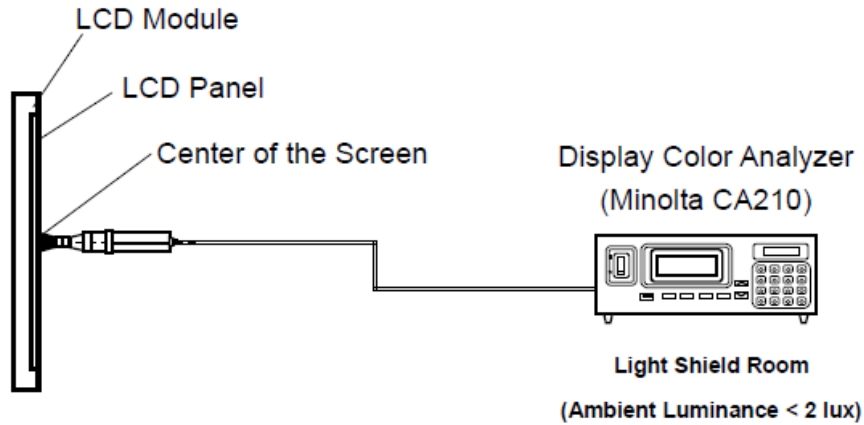

Note 2: Definition of viewing angle

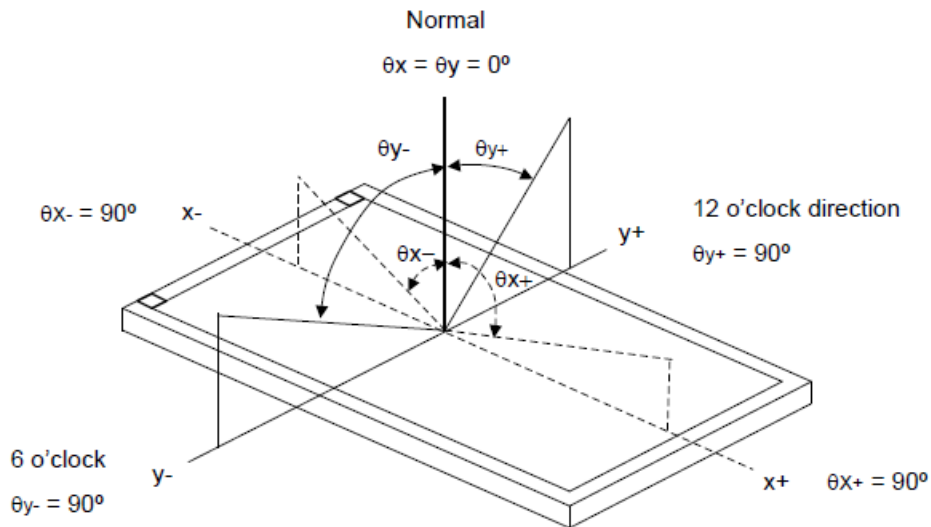

Note 3: Contrast ratio is measured by Minolta CA210

Note 4: Definition of Response time

The output signals of photo detector are measured when the input signals are changed from “Full Black” to “Full White” (rising time), and from “Full White” to “Full Black” (falling time), respectively. The response time is interval between the 10% and 90% of amplitudes. Please refer to the figure as below.

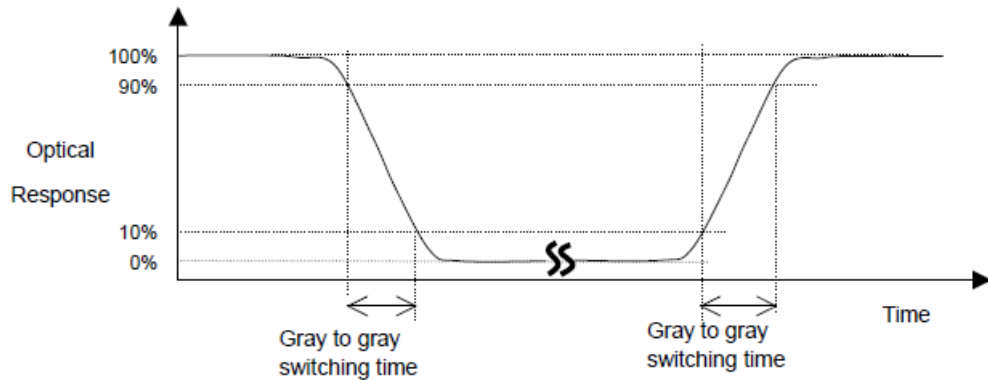

Note 5: Color chromaticity and coordinates (CIE) is measured by Minolta CA210

Note 6: Center luminance is measured by Minolta CA210

Note 7: Luminance uniformity of these 5 points is defined as below and measured by Minolta CA210

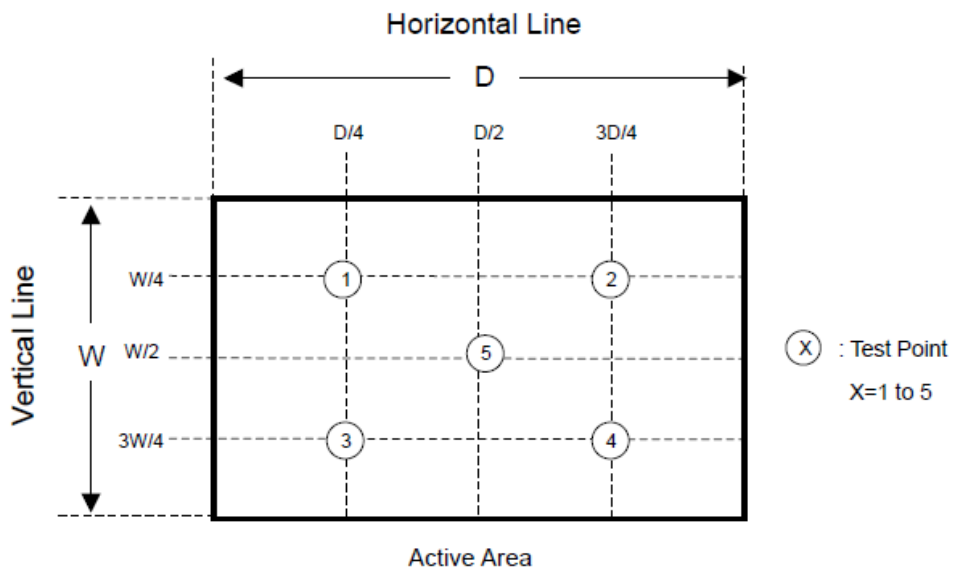

$$\text{Uniformity} = (\text{Min. Luminance of 5 points}) / (\text{Max. Luminance of 5 points})$$

3. Absolute Maximum Ratings

Absolute maximum ratings of the module are as following:

3.1 TFT LCD module

Items	Symbol	Min	Max	Unit	Conditions
Power supply voltage	V _{DD}	-0.3	3.96	Volt	Note 1, 2

3.2 Backlight unit

Items	Symbol	Min	Max	Unit	Conditions
LED bar input current			600	mA	

3.3 Environment

Items	Symbol	Values			Unit	Conditions
		Min.	Typ.	Max.		
Operation temperature	T _{OS}	-30	-	85	°C	Note 3
Operation Humidity	H _{OP}	10		85	%	
Storage temperature	T _{ST}	-40		90	°C	
Storage Humidity	H _{ST}	5		90	%	

Note 1: With in Ta= 25°C

Note 2: Permanent damage to the device may occur if exceed maximum values

Note 3: For quality performance, please refer to IIS (Incoming Inspection Standard).

4. Electrical characteristics

4.1 LCD electronics specification

(GND =0V)

Item	Symbol	Values			Unit	Remark
		Min.	Typ.	Max.		
Power voltage	V _{DD}	3.1	3.3	3.6	V	Note 1,2
Power Supply Input Current	I _{DD}	210	260	310	mA	Note 3
Input logic high voltage	V _{IH}	0.7 V _{DD}	-	V _{DD}	V	Note 4
Input logic low voltage	V _{IL}	GND	-	0.3 V _{DD}	V	
Pull low / high resistor	RI	125	250	375	kΩ	For I/O circuit

Note 1: V_{DD} setting should match the signals output voltage of customer’s system board.

Note 2: The ripple voltage should be controlled under 5% of V_{DD}

Note 3: Full white pattern.

Note 4: RESET, STBYB , RL, TB

4.2 Backlight unit

Parameter	Min	Typ	Max	Unit	Note
LED voltage (VL)		36		[V]	2
LED current (IL)		220		[mA]	2
LED power (PL)		15.84		[W]	
LED lite time (MTBF)		100,000		[Hour]	1

Note 1: The “LED lift time” is defined as the module brightness decrease to 50% original brightness that the ambient temperature is 25°C and typical LED Current at 220 mA

Note 2: The variance of LED Light Bar power consumption is ±10%. Calculator value for reference (IL × VL × 2 = PLED)

4.3 Interface connector

4.3.1 TFT connector(CN1)

Connector on PCB is used for the module electronics interface. The recommended model is 12003S-50Y900 manufactured by IRISO.

Connector type : IRISO 12003S-50Y900					
Pin	Input signal name	I/O pin (I:input, O:output, P:power)	Typical voltage (Volt)		description
1	GND	P	0.00 V	power supply	Ground
2	VDD	P	3.3 V	power supply	External main and I/O power supply ; Power3V3
3	VDD	P	3.3 V	power supply	External main and I/O power supply ; Power3V3
4	VDD	P	3.3 V	power supply	External main and I/O power supply ; Power3V3
5	RESET	I	3.3V or 0V	Function	Global reset pin (Default high), active low.
6	STBYB	I	3.3V or 0V	Function	Standby mode setting pin (Default high), active low.
7	GND	P	0.00 V	power supply	Ground
8	OLV0N	I		LVDS signal	LVDS odd data 0-
9	OLV0P	I		LVDS signal	LVDS odd data 0+
10	GND	P	0.00 V	power supply	Ground
11	OLV1N	I		LVDS signal	LVDS odd data 1-
12	OLV1P	I		LVDS signal	LVDS odd data 1+
13	GND	P	0.00 V	power supply	Ground
14	OLV2N	I		LVDS signal	LVDS odd data 2-
15	OLV2P	I		LVDS signal	LVDS odd data 2+
16	GND	P	0.00 V	power supply	Ground
17	OLVCLKN	I		LVDS signal	LVDS odd clk -
18	OLVCLKP	I		LVDS signal	LVDS odd clk +
19	GND	P	0.00 V	power supply	Ground
20	OLV3N	I		LVDS signal	LVDS odd data 3-
21	OLV3P	I		LVDS signal	LVDS odd data 3+
22	GND	P	0.00 V	power supply	Ground
23	ELV0N	I		LVDS signal	LVDS even data 0-
24	ELV0P	I		LVDS signal	LVDS even data 0+
25	GND	P	0.00 V	power supply	Ground
26	ELV1N	I		LVDS signal	LVDS even data 1-
27	ELV1P	I		LVDS signal	LVDS even data 1+
28	GND	P	0.00 V	power supply	Ground
29	ELV2N	I		LVDS signal	LVDS even data 2-
30	ELV2P	I		LVDS signal	LVDS even data 2+
31	GND	P	0.00 V	power supply	Ground
32	ELVCLKN	I		LVDS signal	LVDS even clk -
33	ELVCLKP	I		LVDS signal	LVDS even clk +
34	GND	P	0.00 V	power supply	Ground
35	ELV3N	I		LVDS signal	LVDS even data 3-
36	ELV3P	I		LVDS signal	LVDS even data 3+
37	GND	P	0.00 V	power supply	Ground
38	GND	P	0.00 V	power supply	Ground

39	RL	I	3.3V or 0V	Function	Horizontal shift direction (source output) selection. RL = 1: Left -> Right(default: Customer to Pull high, internal IC Pull high*) RL = 0: Right -> Left
40	TB	I	3.3V or 0V	Function	Vertical shift direction (gate output) selection. TB = 0: Bottom->Top TB = 1: Top ->Bottom (default: Customer to Pull high, internal IC Pull high*)
41	VDD	P	3.3 V	power supply	External main and I/O power supply ; Power3V3
42	GND	I	0.00 V	power supply	LCD Maker Internal Use
43	GND	I	0.00 V	power supply	LCD Maker Internal Use
44	VDD	P	3.3 V	power supply	External main and I/O power supply ; Power3V3
45	NC				Keep floating
46	NC				Keep floating
47	NC				Keep floating
48	NC				Keep floating
49	NC				Keep floating
50	NC				Keep floating

4.3.2 Backlight connector(CN2 、CN3)

Recommended connector : BHSR-02VS-1 manufactured by JST

Pin no	Symbol	Description	Note
1	V _{LED+}	Backlight LED anode	Red
2	V _{LED-}	Backlight LED cathode	Black

5. Timing characteristics

5.1 LVDS AC electrical characteristics

Parameter	Symbol	Spec.			Unit	Remark
		Min.	Typ.	Max.		
Clock frequency	FLVCYC	20	-	85	MHz	Frame rate=60Hz
Clock Period	TLVCYC	11.76	-	50	Nsec	Frame rate=60Hz
1 data bit time	UI	-	1/7	-	TLVCYC	
Position 1	TPOS1	-0.2	0	0.2	UI	Note9
Position 0	TPOS0	0.8	1	1.2	UI	
Position 6	TPOS6	1.8	2	2.2	UI	
Position 5	TPOS5	2.8	3	3.2	UI	
Position 4	TPOS4	3.8	4	4.2	UI	
Position 3	TPOS3	4.8	5	5.2	UI	

Position 2	TPOS2	5.8	6	6.2	UI	
Input eye width	TEYEW	0.6	-	-	UI	
Input eye border	TEX	-	-	0.2	UI	
LVDS wake up time	TENLVDS	-	-	150	ns	

Note9 : Please refer to "3.3.2 Input Clock and Data Timing Diagram"

5.2 Input clock and data timing diagram

LVDS input timing:

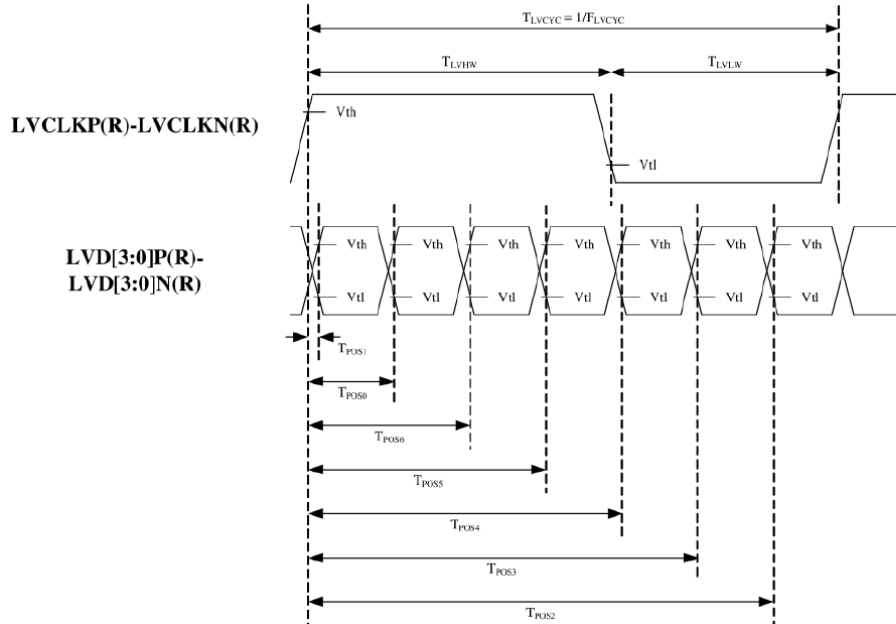

Differential:

LVD[3:0]P-LVD[3:0]N

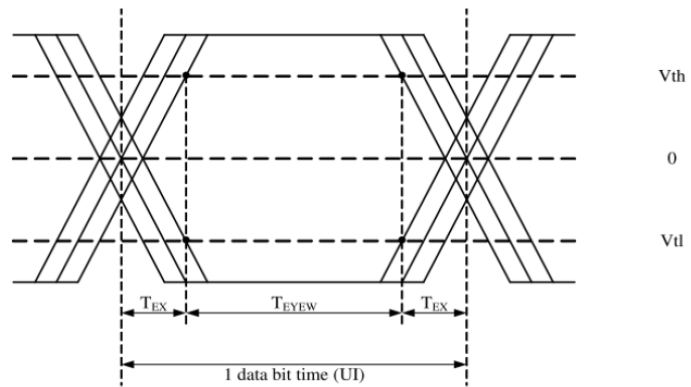

LVDS input eye diagram

5.3LVDS DC electrical characteristics

Parameter	Symbol	Spec.			Unit	Remark
		Min.	Typ.	Max.		
Differential input high Threshold voltage	Vth	-	-	+0.1	V	Vcm=1.2V
Differential input low Threshold voltage	Vtl	-0.1	-	-	V	
Differential input common Mode voltage	Vcm	1	1.2	1.7- V _{id} /2	V	-
Differential input voltage	V _{id}	0.2	-	0.6	V	-
Differential input leakage Current	Vleak	-10	-	+10	μA	-

Single-ended:
LVCLKP(R),
LVCLKN(R),
LVD[3:0]P(R),
LVD[3:0]N(R)

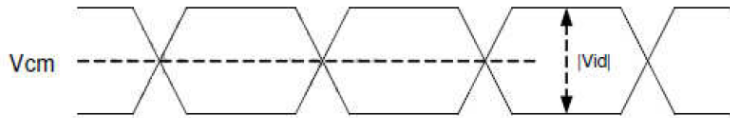

Differential:
LVCLKP(R)-LVCLKN(R),
LVD[3:0]P(R)-
LVD[3:0]N(R)

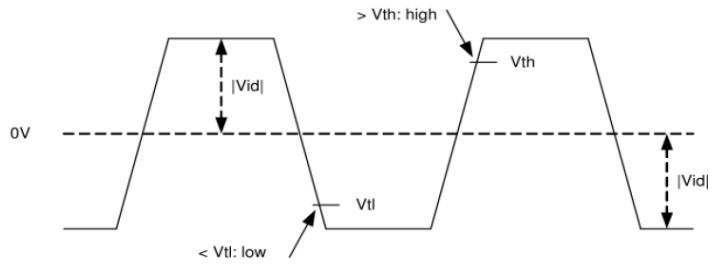

5.4 Timing

Parameter	Symbol	1920xRGBx720 (Two Port LVDS)			Unit
		Min.	Typ.	Max.	
CLK frequency	F_{CLK}	-	44.1	-	MHz
Horizontal valid data	t_{hd}	960			DCLK
1 Horizontal Line	th	984	992	1005	DCLK
Vertical valid data	t_{vd}	720			H
1 Vertical field	t_v	730	741	753	H
Frame rate	FR	59.4	60	60.6	Hz

Note: DE mode only.

5.5 Data input format

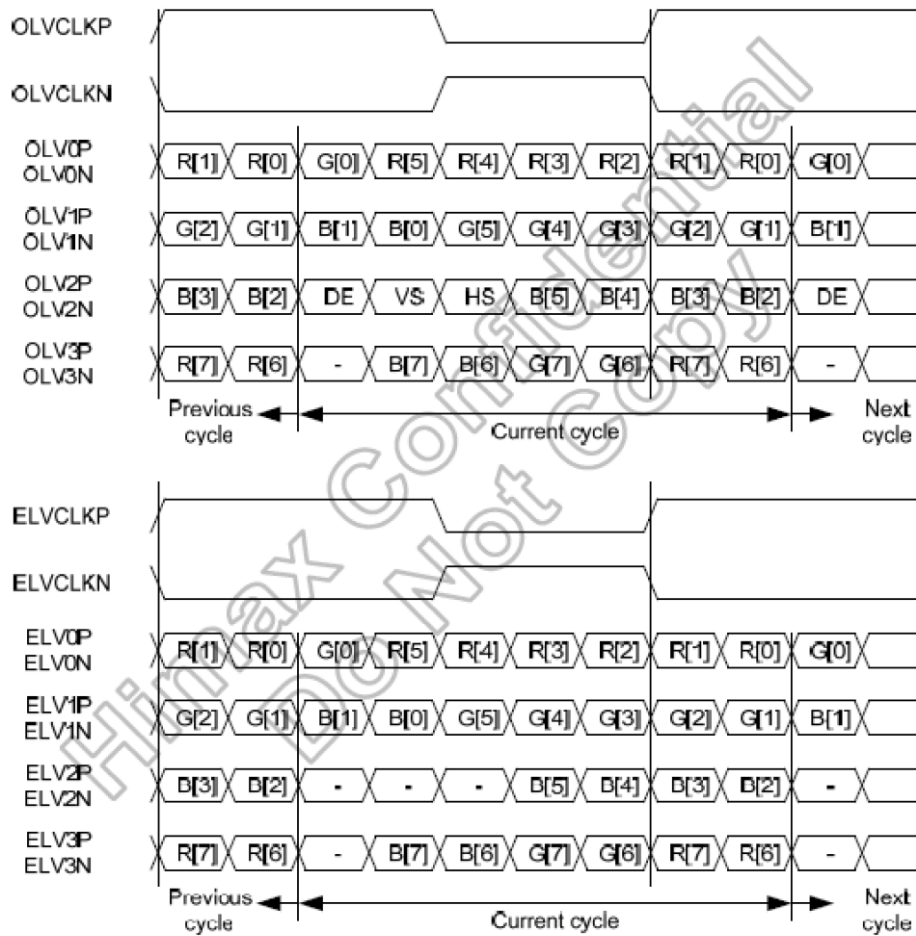

VESA format (8bit)

Notice: Panel LVDS interface Spec, Odd = 1st Pixel, Even = 2nd Pixel

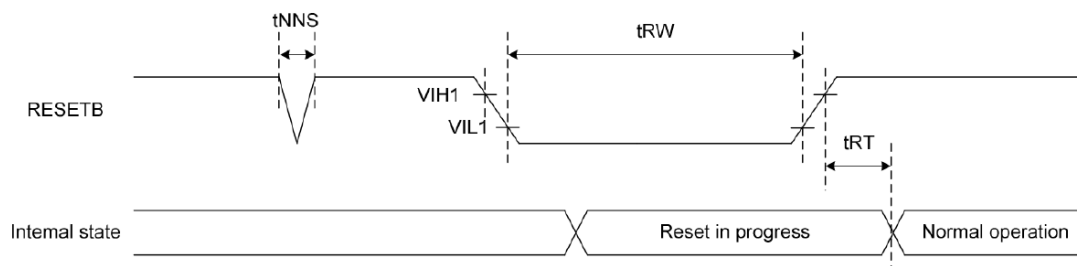

Signal	Parameter	Symbol	Spec.			Unit	Remark
			Min.	Typ.	Max.		
RESETB	Reset pulse width	t_{RW}	10	-	-	μs	-
	Reset complete time	t_{RT}	-	-	5	μs	-
	Negative spike noise width	t_{NNS}	-	-	100	ns	-

6. Reliability Test

Environment test conditions are listed as following table.

Items	Required Condition	Note
Temperature Humidity Bias (THB)	Ta=40°C, 80%RH, 240hours	
High Temperature Operation (HTO)	Ts= 85°C, 240hours	3
Low Temperature Operation (LTO)	Ta= -30°C, 240hours	
High Temperature Storage (HTS)	Ta= 90°C, 240hours	
Low Temperature Storage (LTS)	Ta= -40°C, 240hours	
Thermal Shock Test (TST)	-20°C/30min, 60°C/30min, 100 cycles	
On/Off Test	On/10sec, Off/10sec, 30,000 cycles	
ESD (ElectroStatic Discharge)	Contact Discharge: ± 8KV, 150pF(330Ω) 1sec, 9 points, 25 times/ point.	
	Air Discharge: ± 15KV, 150pF(330Ω) 1sec 9 points, 25 times/ point.	

Note 1: The TFT-LCD module will not sustain damage after being subjected to 100 cycles of rapid temperature change. A cycle of rapid temperature change consists of varying the temperature from -10°C to 50°C, and back again. Power is not applied during the test. After temperature cycling, the unit is placed in normal room ambient for at least 4 hours before power on.

Note 2: According to EN61000-4-2 , ESD class B: Some performance degradation allowed. No data lost. Self-recoverable. No hardware failures.

Note 3: TFT surface.

7. Shipping package (TBD)

No.	Item	Model (Material)	Dimensions(mm)	Unit Weight (kg)	Quantity	Remark
1	LCM Module	Model Name	310(W) X 129(H) X 7.5(D) mm	0.53	20	
2	EPO Box	EPO	542 x 382 x 182mm	0.61	1	
3	A/S Bag	PE	340 x 183 x 0.04mm	0.006	20	
4	Carton	Corrugated Paper	566 x 406 x 216mm	1.014	1	
5	Total Weight	12.34 kg				

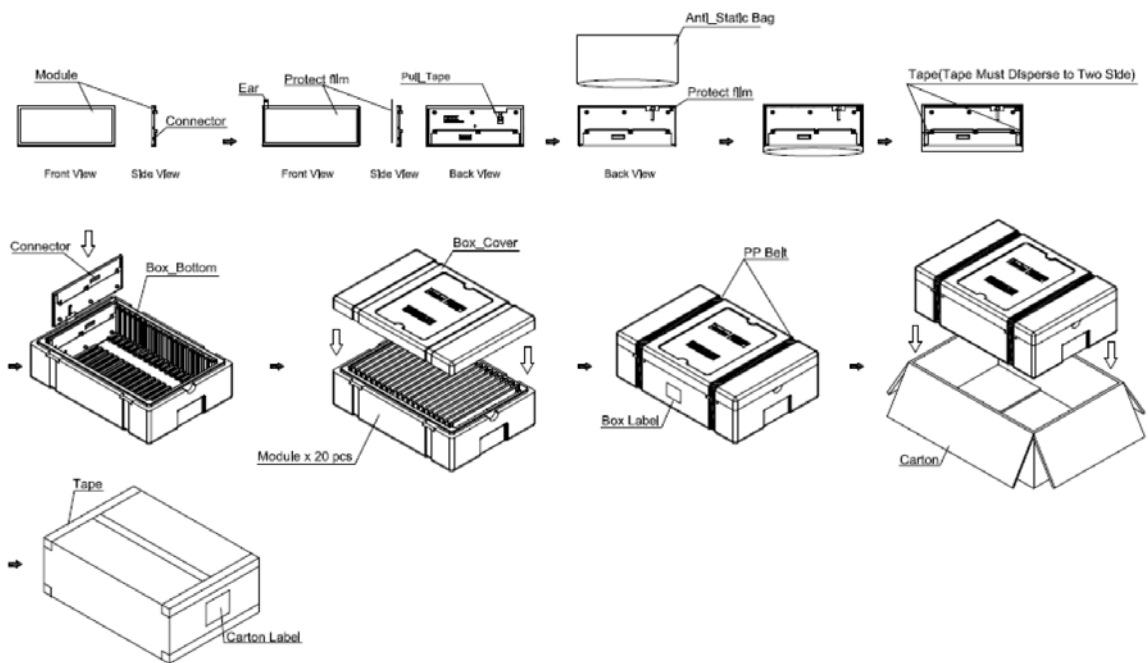

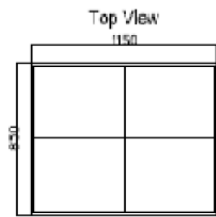

Top View
1150
950

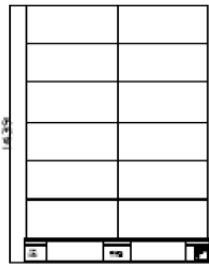

1435
Front View
(Air trans)

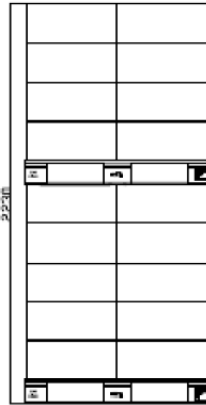

2220
Front View
(Sea trans for normal cont)

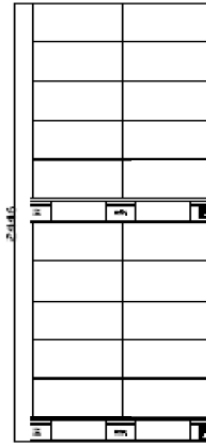

2485
Front View
(Sea trans for HQ)

