

7.0" WVGA
High brightness color TFT-LCD module

Model: VM07B1 V1

Version : 01

Date: May. 5th, 2022

**Note: This specification is subject to change
without notice**

Customer : _____

Date : _____

Approved

Prepared

Date:

Date:

Contents

- 1. Handling Precautions**
- 2. General Description**
 - 2.1 Overview
 - 2.2 Features
 - 2.3 Application
 - 2.4 Display specifications
 - 2.5 Optical characteristics
- 3. Absolute Maximum Ratings**
 - 3.1 TFT LCD module
 - 3.2 Backlight unit
 - 3.3 Environment
- 4. Electrical characteristics**
 - 4.1 LCD electronics specification
 - 4.1.1 Power specification
 - 4.2 Backlight unit
 - 4.3 Interface connector
 - 4.3.1 TFT connector(CN1)
 - 4.3.2 Backlight connector(CN2)
- 5. Signal characteristics**
 - 5.1 Timing characteristics
 - 5.1.1 AC electrical characteristics
 - 5.1.2 Data input format
 - 5.1.3 Timing
 - 5.2 Power ON/OFF sequence
- 6. Reliability Test**
- 7. Shipping package**
- 8. Mechanical Characteristics**

RECORD OF REVISION

Version and Date	Page	Old description	New description	Remark
0.1 2014/06/30	All	First Edition for customer		
0.2 2021/09/13	6	Total power : 3.466W	Total power : 3.106W	
		LED power : 3.24W	LED power : 2.88W	
	13	LED voltage : 9V	LED voltage : 18V	
		LED current : 360mA	LED current : 160mA	
		MTBF : 50,000 hr	MTBF : 100,000 hr	
0.3 2022/05/05	24	LED cable : 100mm	LED cable : 135.0mm	

1. Handling Precautions

- 1) Since front polarizer is easily damaged, pay attention not to scratch it.
- 2) Be sure to turn off power supply when inserting or disconnecting from input connector.
- 3) Wipe off water drop immediately. Long contact with water may cause discoloration or spots.
- 4) When the panel surface is soiled, wipe it with absorbent cotton or other soft cloth.
- 5) Since the panel is made of glass, it may break or crack if dropped or bumped on hard surface.
- 6) Since CMOS LSI is used in this module, take care of static electricity and insure human earth when handling.
- 7) Do not open or modify the Module Assembly.
- 8) Do not press the reflector sheet at the back of the module to any directions.
- 9) At the insertion or removal of the Signal Interface Connector, be sure not to rotate nor tilt the Interface Connector of the TFT Module.
- 10) After installation of the TFT Module into an enclosure, do not twist nor bend the TFT Module even momentary. At designing the enclosure, it should be taken into consideration that no bending/twisting forces are applied to the TFT Module from outside. Otherwise the TFT Module may be damaged.

2. General Description

2.1 Overview

This specification applies to the Color Active Matrix Liquid Crystal Display composed of a TFT-LCD display a LED backlight system. The screen format is intended to support WVGA (800(H) x 480(V)) screen and 16.7M (8 bits) color support.

2.2 Features

- High brightness display, 1000nits by LED backlight.
- Long operation lifetime BLU design
- Wide operation temperature
- RoHS Compliance

2.3 Application

Industrial applications.

2.4 Display specifications

Items	Unit	Specification
Screen Diagonal	inch	7.0"
Active Area	mm	154.08 (H) X 85.92 (V)
Pixels H x V	pixels	800 x3(RGB) x 480
Pixels Pitch	um	192 (per one triad) x 179
Pixel Arrangement		RGB Vertical stripe
Display mode		Normally white, Transmissive
White luminance (center)	Cd/m ²	1000 (Typ)
Contrast ratio		500:1 (Typ.)
Optical Response Time	msec	25 ms (Typ. On/off)
Normal Input Voltage (VDD /AVDD/VGH/VGL/VCOM)	Volt	3.3 / 10.4 / 16.0 / -7.0 / (3.6)
Power Consumption (Vcc Line + LED backlight)	Watt	3.106 W (VDD line=0.226 W; LED lines= 2.88 W)
Weight	Grams	154
Physical size	mm	164.9 (W)× 100.0 (H)× 5.7 (D)
Electrical Interface		Digital
Support colors		16.7M colors (8 bits)
Surface Treatment		Hard coating
Temperature range		
Operating	°C	-30 ~ 85 (TFT surface)
Storage	°C	-30 ~ 85
RoHS Compliance		RoHS Compliance

2.5 Optical characteristics

The following optical characteristics are measured under stable condition at 25 °C

Items	Unit	Conditions	Min.	Typ.	Max.	Note
Viewing angle	Deg.	Horizontal (Right)	60	70		2
		CR=10 (Left)	60	70		
		Vertical (Up)	40	50		
		CR=10 (Down)	60	70		
Contrast Ratio		Normal Direction	400	500		3
Response Time	msec	Raising + Falling		25	50	4
Color coordinates (CIE) White		White x	-0.05	0.31	+0.05	5
		White y		0.33		
Center Luminance	Cd/m ²		800	1000		6
Luminance Uniformity	%		70	75		7
Crosstalk (in 60 Hz)	%				1.5	
Flicker	dB				-20	

Note 1: Measurement method

The LCD module should be stabilized at given temperature for 0.5 hour to avoid abrupt temperature change during measuring. In order to stabilize the luminance, the measurement should be executed after lighting Backlight for 1 hour in a windless room.

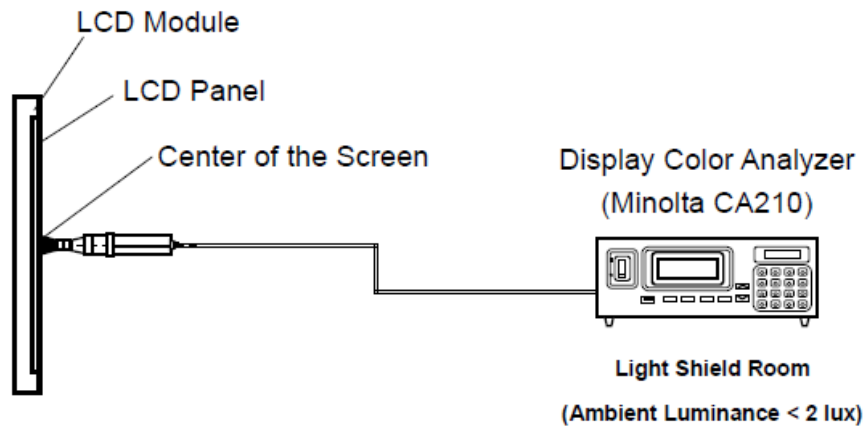

Note 2: Definition of viewing angle

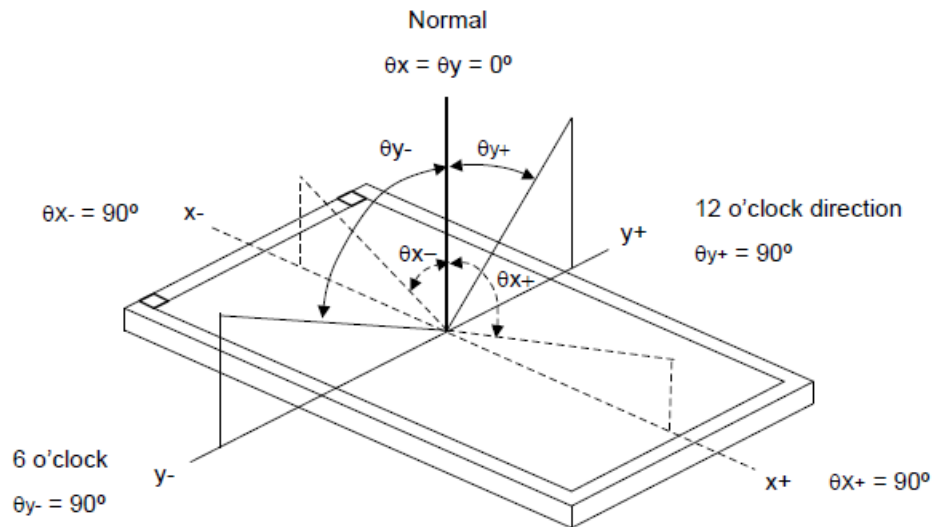

Note 3: Contrast ratio is measured by Minolta CA210

Note 4: Definition of Response time

The output signals of photo detector are measured when the input signals are changed from “Full Black” to “Full White” (rising time), and from “Full White” to “Full Black” (falling time), respectively. The response time is interval between the 10% and 90% of amplitudes. Please refer to the figure as below.

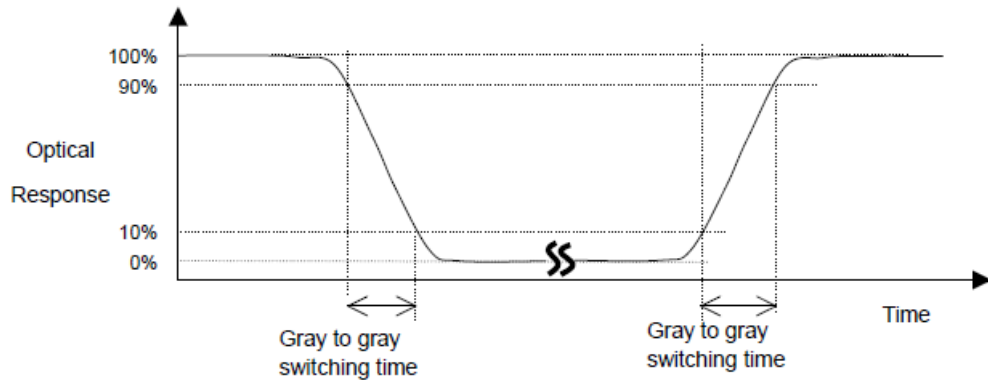

Note 5: Color chromaticity and coordinates (CIE) is measured by Minolta CA210

Note 6: Center luminance is measured by Minolta CA210

Note 7: Luminance uniformity of these 5 points is defined as below and measured by Minolta CA210

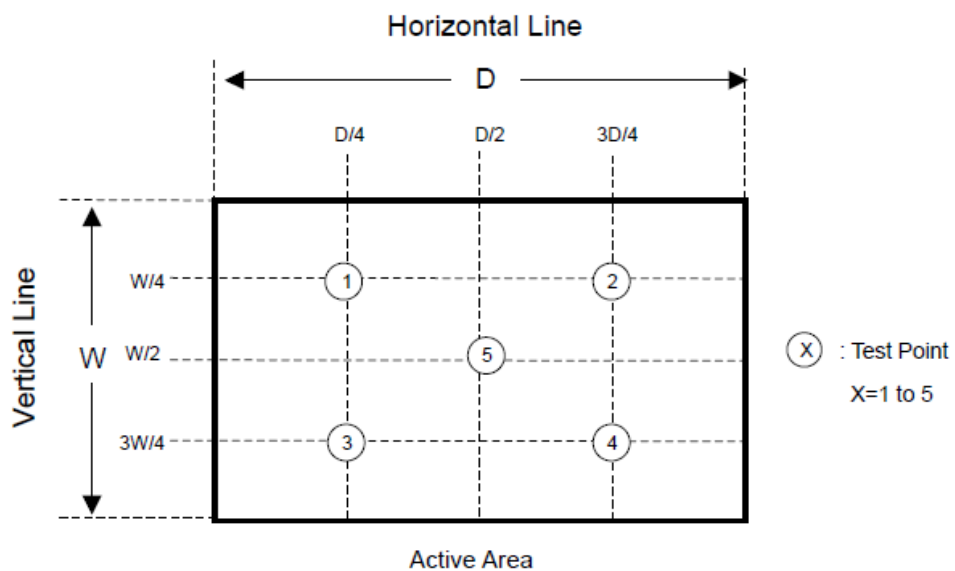

$$\text{Uniformity} = (\text{Min. Luminance of 5 points}) / (\text{Max. Luminance of 5 points})$$

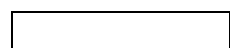

3. Absolute Maximum Ratings

Absolute maximum ratings of the module are as following:

3.1 TFT LCD module

(Note 1)

Item	Symbol	Values		Unit	Remark
		Min.	Max.		
Power voltage	DV _{DD}	-0.3	5.0	V	
	AV _{DD}	6.5	13.5	V	
	V _{GH}	-0.3	40.0	V	
	V _{GL}	-20.0	0.3	V	
	V _{GH} -V _{GL}	-	40.0	V	

Note 1: The absolute maximum rating values of this product are not allowed to be exceeded at any times. Should a module be used with any of the absolute maximum ratings exceeded, the characteristics of the module may not be recovered, or in an extreme case, the module may be permanently destroyed.

3.2 Backlight unit

Items	Symbol	Min	Max	Unit	Conditions
LED bar input current			600	mA	

3.3 Environment

Items	Symbol	Values			Unit	Conditions
		Min.	Typ.	Max.		
Operation temperature	T _{OS}	-30	-	85	°C	Note 3
Operation Humidity	H _{OP}	10		85	%	
Storage temperature	T _{ST}	-30		85	°C	
Storage Humidity	H _{ST}	5		90	%	

Note 1: With in Ta= 25°C

Note 2: Permanent damage to the device may occur if exceed maximum values

Note 3: For quality performance, please refer to IIS (Incoming Inspection Standard).

4. Electrical characteristics

4.1 LCD electronics specification

4.1.1 Power specification

Item	Symbol	Values			Unit	Remark
		Min.	Typ.	Max.		
Power voltage	DV _{DD}	3.0	3.3	3.6	V	Note 2
	AV _{DD}	10.2	10.4	10.6	V	
	V _{GH}	15.3	16.0	16.7	V	
	V _{GL}	-7.7	-7.0	-6.3	V	
Input signal voltage	V _{COM}	2.6	(3.6)	4.6	V	Note 4
Input logic high voltage	V _{IH}	0.7 DV _{DD}	-	DV _{DD}	V	Note 3
Input logic low voltage	V _{IL}	0	-	0.3 DV _{DD}	V	

Note 1: Be sure to apply DV_{DD} and V_{GL} to the LCD first, and then apply V_{GH}.

Note 2: DV_{DD} setting should match the signals output voltage (refer to Note 3) of customer's system board.

Note 3: DCLK,HS,VS,RESET,U/D, L/R,DE,R0~R7,G0~G7,B0~B7,MODE,DITHB.

Note 4: Typical V_{COM} is only a reference value. It must be optimized according to each LCM. Please use VR and base on below application circuit.

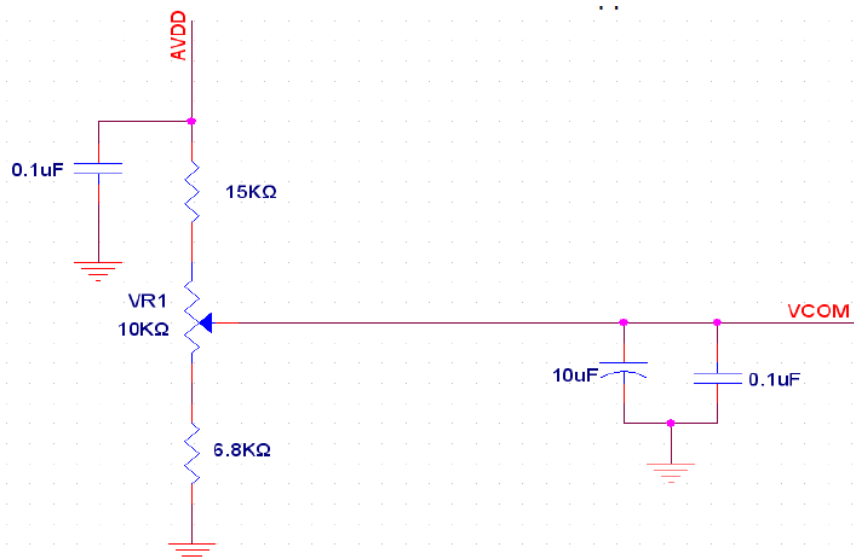

Item	Symbol	Values			Unit	Remark
		Min.	Typ.	Max.		
Current for Driver	I_{GH}	0.05	0.2	1.0	mA	$V_{GH} = 16.0V$
	I_{GL}	0.05	0.2	1.0	mA	$V_{GL} = -7.0V$
	IDV_{DD}	1	4.0	10	mA	$DV_{DD} = 3.3V$
	IAV_{DD}	5	20	50	mA	$AV_{DD} = 10.4V$

4.2 Backlight unit

Parameter	Min	Typ	Max	Unit	Note
LED voltage (VL)		18		[V]	2
LED current (IL)		160		[mA]	2
LED power (PL)		2.88		[W]	
LED lite time (MTBF)		100,000		[Hour]	1

Note 1: The "LED lift time" is defined as the module brightness decrease to 50% original brightness that the ambient temperature is 25°C and typical LED Current at 160 mA

Note 2: The variance of LED Light Bar power consumption is ±10%. Calculator value for reference ($IL \times VL = PLED$)

4.3 Interface connector

4.3.1 TFT connector(CN1)

FPC Connector is used for the module electronics interface. The recommended model is FH12A-50S-0.5SH manufactured by Hirose.

Pin No.	Symbol	I/O	Function	Remark
1	NC	-	No connection	
2	NC	-	No connection	
3	NC	-	No connection	
4	NC	-	No connection	
5	GND	P	Power ground	
6	V _{COM}	I	Common voltage	
7	DV _{DD}	P	Power for Digital Circuit	
8	MODE	I	DE/SYNC mode select	Note 1
9	DE	I	Data Input Enable	
10	VS	I	Vertical Sync Input	
11	HS	I	Horizontal Sync Input	
12	B7	I	Blue data(MSB)	
13	B6	I	Blue data	
14	B5	I	Blue data	
15	B4	I	Blue data	
16	B3	I	Blue data	
17	B2	I	Blue data	
18	B1	I	Blue data	Note 2
19	B0	I	Blue data(LSB)	Note 2
20	G7	I	Green data(MSB)	
21	G6	I	Green data	
22	G5	I	Green data	
23	G4	I	Green data	
24	G3	I	Green data	
25	G2	I	Green data	

26	G1	I	Green data	Note 2
27	G0	I	Green data(LSB)	Note 2
28	R7	I	Red data(MSB)	
29	R6	I	Red data	
30	R5	I	Red data	
31	R4	I	Red data	
32	R3	I	Red data	
33	R2	I	Red data	
34	R1	I	Red data	Note 2
35	R0	I	Red data(LSB)	Note 2
36	GND	P	Power Ground	
37	DCLK	I	Sample clock	Note 3
38	GND	P	Power Ground	
39	L/R	I	Left / right selection	Note 4,5
40	U/D	I	Up/down selection	Note 4,5
41	V _{GH}	P	Gate ON Voltage	
42	V _{GL}	P	Gate OFF Voltage	
43	AV _{DD}	P	Power for Analog Circuit	
44	RESET	I	Global reset pin.	Note 6
45	NC	-	No connection	
46	V _{COM}	I	Common Voltage	
47	DITHB	I	Dithering function	Note 7
48	GND	P	Power Ground	
49	NC	-	No connection	
50	NC	-	No connection	

I: input, O: output, P: Power

Note 1: DE/SYNC mode select. Normally pull high.

When select DE mode, MODE="1", VS and HS must pull high.

When select SYNC mode, MODE="0", DE must be grounded.

Note 2: When input 18 bits RGB data, the two low bits of R,G and B data must be grounded.

Note 3: Data shall be latched at the falling edge of DCLK.

Note 4: Selection of scanning mode

Setting of scan control input		Scanning direction
U/D	L/R	
GND	DV _{DD}	Up to down, left to right
DV _{DD}	GND	Down to up, right to left
GND	GND	Up to down, right to left
DV _{DD}	DV _{DD}	Down to up, left to right

Note 5: Definition of scanning direction.
Refer to the figure as below:

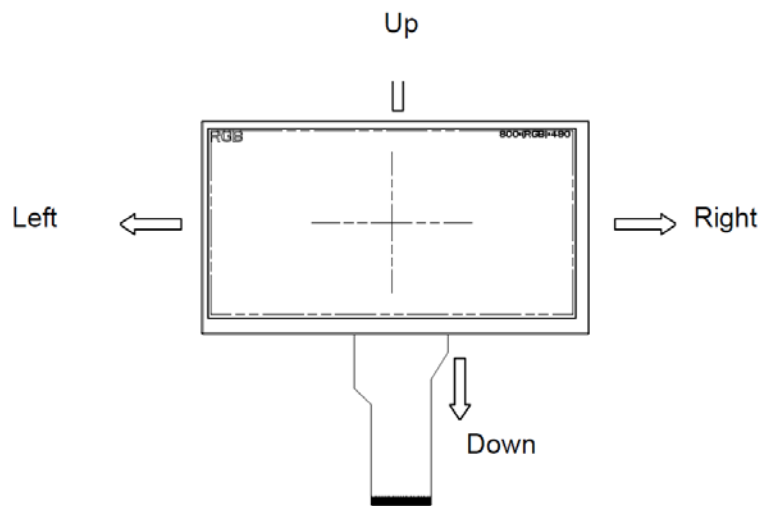

Note 6: Global reset pin. Active low to enter reset state. Suggest to connect with an RC reset circuit for stability. Normally pull high.

Note 7: Dithering function enable control, normally pull high.
When DITHB="1", Disable internal dithering function,
When DITHB="0", Enable internal dithering function,

4.3.2 Backlight connector(CN2)

Recommended connector : BHSR-02VS-1 manufactured by JST

Pin no	Symbol	I/O	Description	Remark
1	VLED+	P	Backlight LED anode	Red
2	VLED-	P	Backlight LED cathode	Black

5. Signal characteristics

5.1 Timing characteristics

5.1.1 AC electrical characteristics

Item	Symbol	Values			Unit	Remark
		Min.	Typ.	Max.		
HS setup time	T_{hst}	8	10	12	ns	
HS hold time	T_{hhd}	8	10	12	ns	
VS setup time	T_{vst}	8	10	12	ns	
VS hold time	T_{vhd}	8	10	12	ns	
Data setup time	T_{dsu}	8	10	12	ns	
Data hole time	T_{dhd}	8	10	12	ns	
DE setup time	T_{esu}	8	10	12	ns	
DE hole time	T_{ehd}	8	10	12	ns	
DV _{DD} Power On Slew rate	T_{POR}	0.5	5	20	ms	From 0 to 90% DV _{DD}
RESET pulse width	T_{Rst}	1	2	5	ms	
DCLK cycle time	T_{coh}	20	30	33	ns	
DCLK pulse duty	T_{cwh}	40	50	60	%	

Input clock and data timing diagram

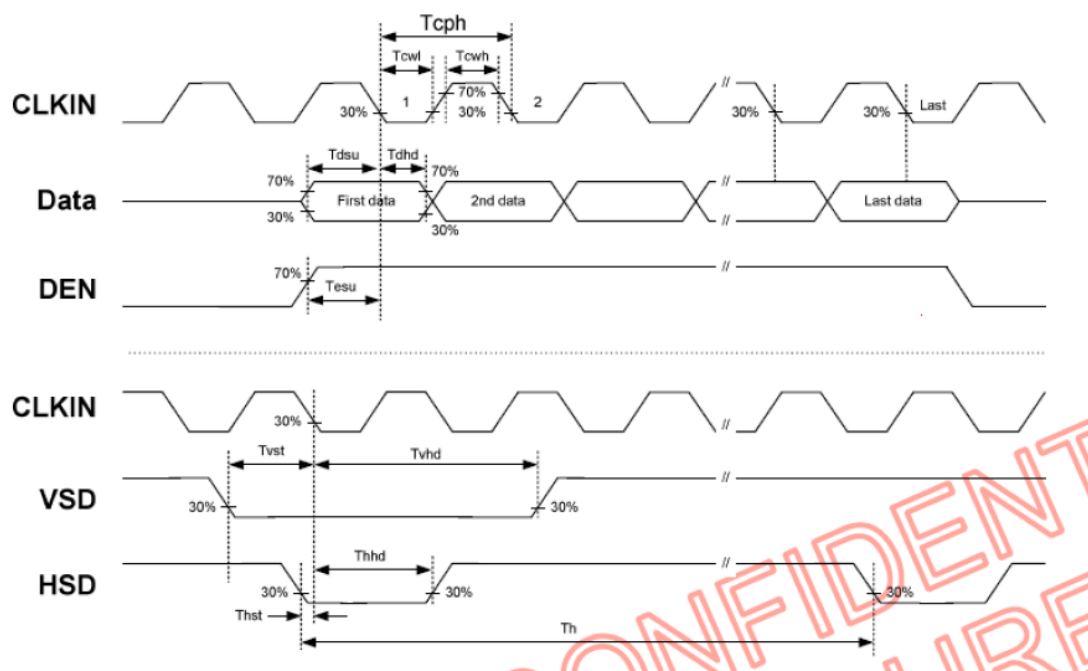

5.1.2 Data input format

Horizontal input timing diagram



Vertical input timing diagram

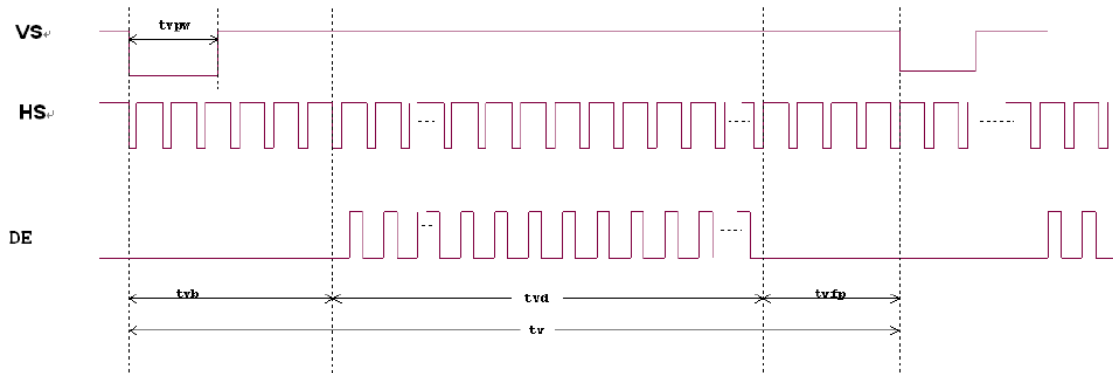

5.1.3 Timing

D

Item	Symbol	Values			Unit	Remark
		Min.	Typ.	Max.		
Horizontal Display Area	thd	-	800	-	DCLK	
DCLK Frequency	fclk	26.4	33.3	46.8	MHz	
One Horizontal Line	th	862	1056	1200	DCLK	
HS pulse width	thpw	1	6	40	DCLK	
HS Blanking	thb	46	46	46	DCLK	
HS Front Porch	thfp	16	204	354	DCLK	

Item	Symbol	Values			Unit	Remark
		Min.	Typ.	Max.		
Vertical Display Area	tvd	-	480	-	TH	
VS period time	tv	510	525	650	TH	
VS pulse width	tvpw	1	3	20	TH	
VS Blanking	tvb	23	23	23	TH	
VS Front Porch	tvfp	7	22	147	TH	

Note: Frame rate is 60 ± 5Hz

5.2 Power ON/OFF sequence

a. Power on:

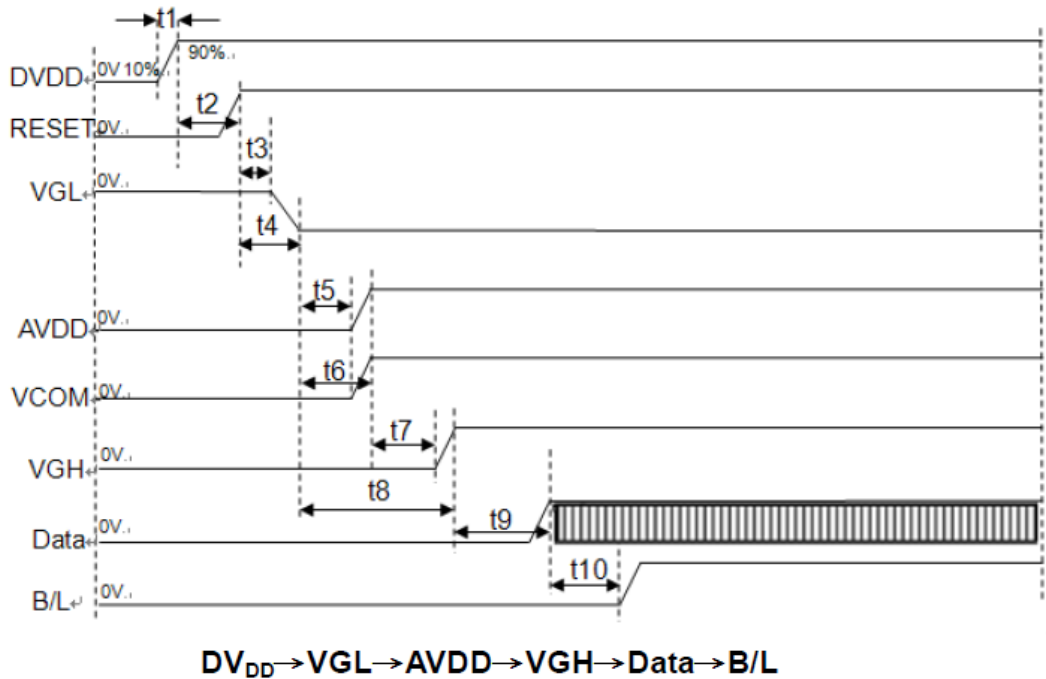

Symbol	SPEC			Unit
	Min.	Typ.	Max.	
t1	0.5	5	20	ms
t2	1	1	1.5	ms
t3	10	15	20	ms
t4	20	22	24	ms
t5	1	2	3	ms
t6	5	6	7	ms
t7	1.5	2	4	ms
t8	10	12	15	ms
t9	10	15	20	ms
t10	180	190	200	ms

Note: Data include R0~R7, B0~B7, GO~G7, U/D, L/R, DCLK, HS, VS, DE.
 Note: Be sure to apply DV_{DD} and V_{GL} to the LCD first, and then apply V_{GH} .

b. Power off:

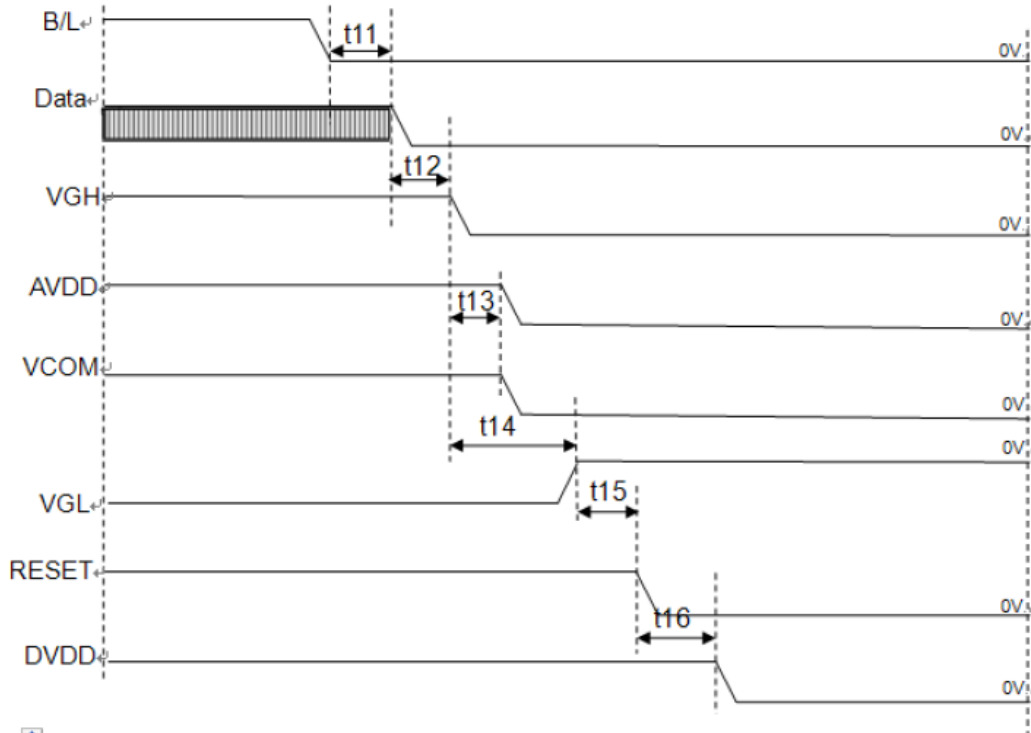

B/L → Data → VGH → AVDD → VGL → DV_{DD}

Symbol	SPEC			Unit
	Min.	Typ.	Max.	
t11	180	190	200	ms
t12	10	15	20	ms
t13	5	6	7	ms
t14	10	12	15	ms
t15	20	22	24	ms
t16	1	1.5	3	ms

Note: Data include R0~R7, B0~B7, GO~G7, U/D, L/R, DCLK, HS,VS,DE.

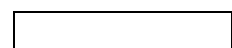

6. Reliability Test

Environment test conditions are listed as following table.

Items	Required Condition	Note
Temperature Humidity Bias (THB)	Ta=40°C, 80%RH, 240hours	
High Temperature Operation (HTO)	Ts= 85°C, 240hours	3
Low Temperature Operation (LTO)	Ta= -30°C, 240hours	
High Temperature Storage (HTS)	Ta= 85°C, 240hours	
Low Temperature Storage (LTS)	Ta= -30°C, 240hours	
Thermal Shock Test (TST)	-20°C/30min, 60°C/30min, 100 cycles	
On/Off Test	On/10sec, Off/10sec, 3,000 cycles	
ESD (ElectroStatic Discharge)	± 2KV, 100pF(500Ω) human body mode.	

Note 1: The TFT-LCD module will not sustain damage after being subjected to 100 cycles of rapid temperature change. A cycle of rapid temperature change consists of varying the temperature from -10°C to 50°C, and back again. Power is not applied during the test.

After temperature cycling, the unit is placed in normal room ambient for at least 4 hours before power on.

Note 3: TFT surface.

**7. Shipping package
(TBD)**

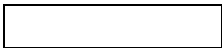

8. Mechanical Characteristics

