

**8.4" XGA****High brightness color TFT-LCD module****Model: VM08BC V3****Date: Apr. 18<sup>th</sup>, 2022****Note: This specification is subject to change  
without notice****Customer :** \_\_\_\_\_**Date :** \_\_\_\_\_**Approved****Prepared****Date:****Date:**

## Contents

### **1. Handling Precautions**

### **2. General Description**

2.1 Overview

2.2 Features

2.3 Application

2.4 Display specifications

2.5 Optical characteristics

### **3. Diagram**

### **4. Absolute Maximum Ratings**

4.1 TFT LCD module

4.2 Backlight unit

4.3 Environment

### **5. Electrical characteristics**

5.1 TFT LCD module

5.1.1 Power specification

5.2 Backlight unit

5.3 Interface connector

5.3.1 TFT connector(CN1)

5.3.2 Backlight connector(CN2)

### **6. Signal characteristics**

6.1 LCD panel power ON/OFF sequence

### **7. Timing chart**

7.1 LVDS interface timing characteristics

7.1.1 LVDS input data format 8-bit LVDS VESA

7.1.2 LVDS input data format 6-bit LVDS VESA

7.2 Input timing table

7.3 LVDS input timing format

7.4 LVDS interface AC characteristics

### **8. Reliability Test**

### **9. Shipping package**

### **10. Mechanical Characteristics**

## RECORD OF REVISION

Version and Date	Page	Old description	New description	Remark
0.1 2022/04/18	All	First Edition for customer		

## 1. Handling Precautions

- 1) Since front polarizer is easily damaged, pay attention not to scratch it.
- 2) Be sure to turn off power supply when inserting or disconnecting from input connector.
- 3) Wipe off water drop immediately. Long contact with water may cause discoloration or spots.
- 4) When the panel surface is soiled, wipe it with absorbent cotton or other soft cloth.
- 5) Since the panel is made of glass, it may break or crack if dropped or bumped on hard surface.
- 6) Since CMOS LSI is used in this module, take care of static electricity and insure human earth when handling.
- 7) Do not open or modify the Module Assembly.
- 8) Do not press the reflector sheet at the back of the module to any directions.
- 9) At the insertion or removal of the Signal Interface Connector, be sure not to rotate nor tilt the Interface Connector of the TFT Module.
- 10) After installation of the TFT Module into an enclosure, do not twist nor bend the TFT Module even momentary. At designing the enclosure, it should be taken into consideration that no bending/twisting forces are applied to the TFT Module from outside. Otherwise the TFT Module may be damaged.

## 2. General Description

### 2.1 Overview

This specification applies to the Color Active Matrix Liquid Crystal Display composed of a TFT-LCD display a LED backlight system. The screen format is intended to support XGA (1024(H) x 768(V)) screen and 16.7M / 262K colors.

### 2.2 Features

- High brightness display, 2000nits by LED backlight.
- Long operation lifetime BLU design
- RoHS Compliance
- Wide operation temperature
- Wide view angle

### 2.3 Application

Industrial applications.

### 2.4 Display specifications

Items	Unit	Specification
Screen Diagonal	inch	8.4"
Active Area	mm	170.496 (H) X 127.872 (V)
Pixels H x V	pixels	1024 x3(RGB) x 768
Pixels Pitch	um	166.5 (per one triad) x 166.5
Pixel Arrangement		RGB Vertical stripe
Display mode		Normally black, SFT mode.
White luminance (center)	Cd/m <sup>2</sup>	2000 (Typ)
Contrast ratio		1000:1 (Typ.)
Optical Response Time	msec	25 ms (Typ. On/off)
Normal Input Voltage VDD	Volt	3.3
Power Consumption (Vcc Line + LED backlight)	Watt	9.663 W (VDD line=1.023 W; LED lines= 8.64 W)
Weight	Grams	301
Physical size	mm	199.5 (W)×149 (H)×9.7 (D)
Electrical Interface		LVDS
Support colors		16.7M / 262K colors
Surface Treatment		Anti-glare and hard-coating 3H
Temperature range		
Operating	°C	-30 ~ 80 (TFT surface)
Storage	°C	-40 ~ 90
RoHS Compliance		RoHS Compliance

### 2.5 Optical characteristics

The following optical characteristics are measured under stable condition at 25 °C

Items	Unit	Conditions	Min.	Typ.	Max.	Note
Viewing angle	Deg.	Horizontal (Right)	80	88		2
		CR=10 (Left)	80	88		
		Vertical (Up)	80	88		
		CR=10 (Down)	80	88		
Contrast Ratio		Normal Direction	800	1000		3
Response Time	msec	Raising + Falling		25	30	4
Color coordinates (CIE)		Red x	-0.05	0.630	+0.05	
		Red y		0.331		
		Green x		0.302		
		Green y		0.625		
		Blue x		0.153		
		Blue y		0.062		
		White x		0.289		
		White y		0.308		
5						
Center Luminance	Cd/m <sup>2</sup>		1600	2000		6
Luminance Uniformity	%		70	75		7
Crosstalk (in 60 Hz)	%				1.5	
Flicker	dB				-20	

**Note 1: Measurement method**

The LCD module should be stabilized at given temperature for 0.5 hour to avoid abrupt temperature change during measuring. In order to stabilize the luminance, the measurement should be executed after lighting Backlight for 1 hour in a windless room.

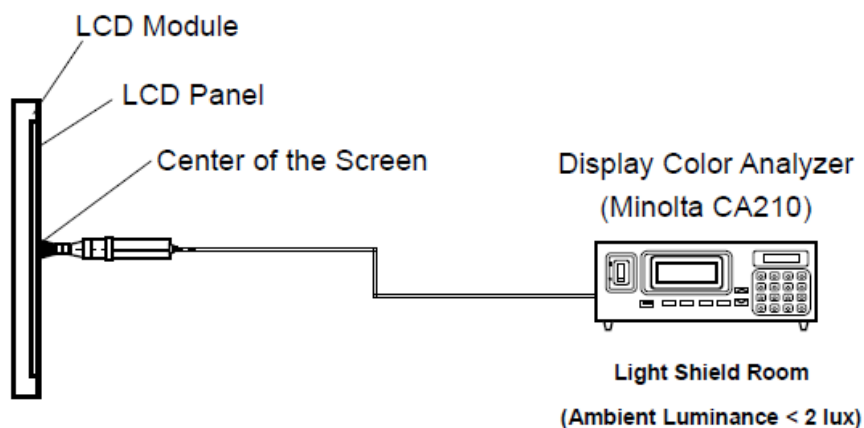

**Note 2: Definition of viewing angle**

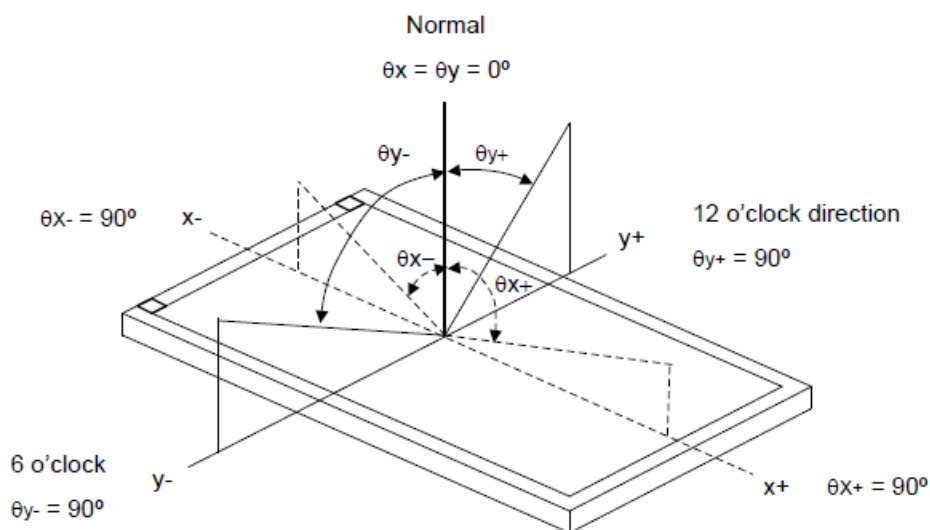

**Note 3: Contrast ratio is measured by Minolta CA210**



**Note 4: Definition of Response time**

The output signals of photo detector are measured when the input signals are changed from “Full Black” to “Full White” (rising time), and from “Full White” to “Full Black” (falling time), respectively. The response time is interval between the 10% and 90% of amplitudes. Please refer to the figure as below.

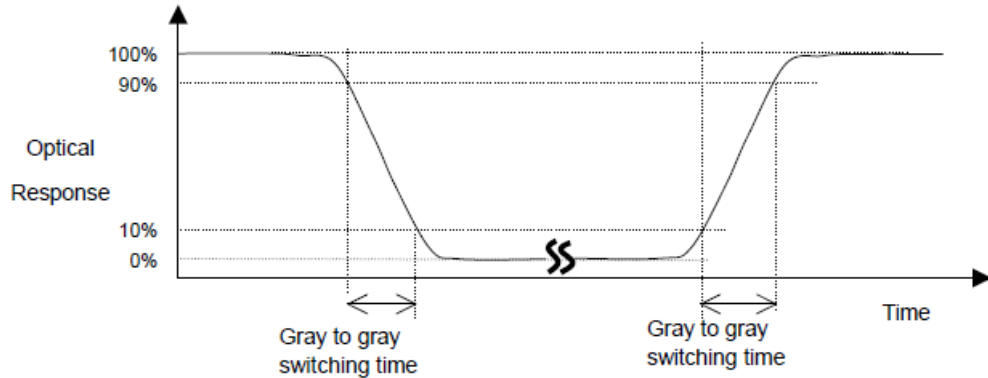

Note 5: Color chromaticity and coordinates (CIE) is measured by Minolta CA210

Note 6: Center luminance is measured by Minolta CA210

Note 7: Luminance uniformity of these 5 points is defined as below and measured by Minolta CA210

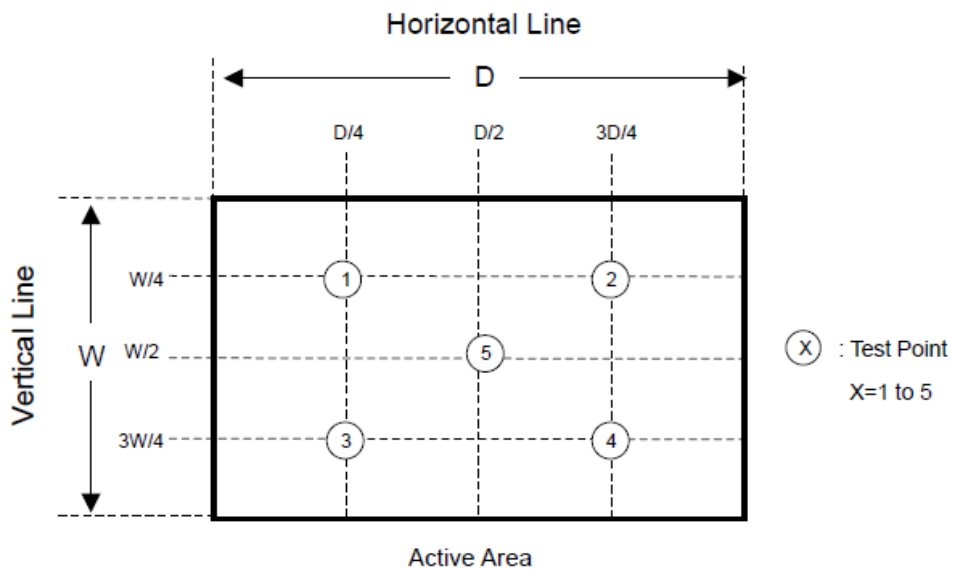

$$\text{Uniformity} = (\text{Min. Luminance of 5 points}) / (\text{Max. Luminance of 5 points})$$

**3. Diagram**

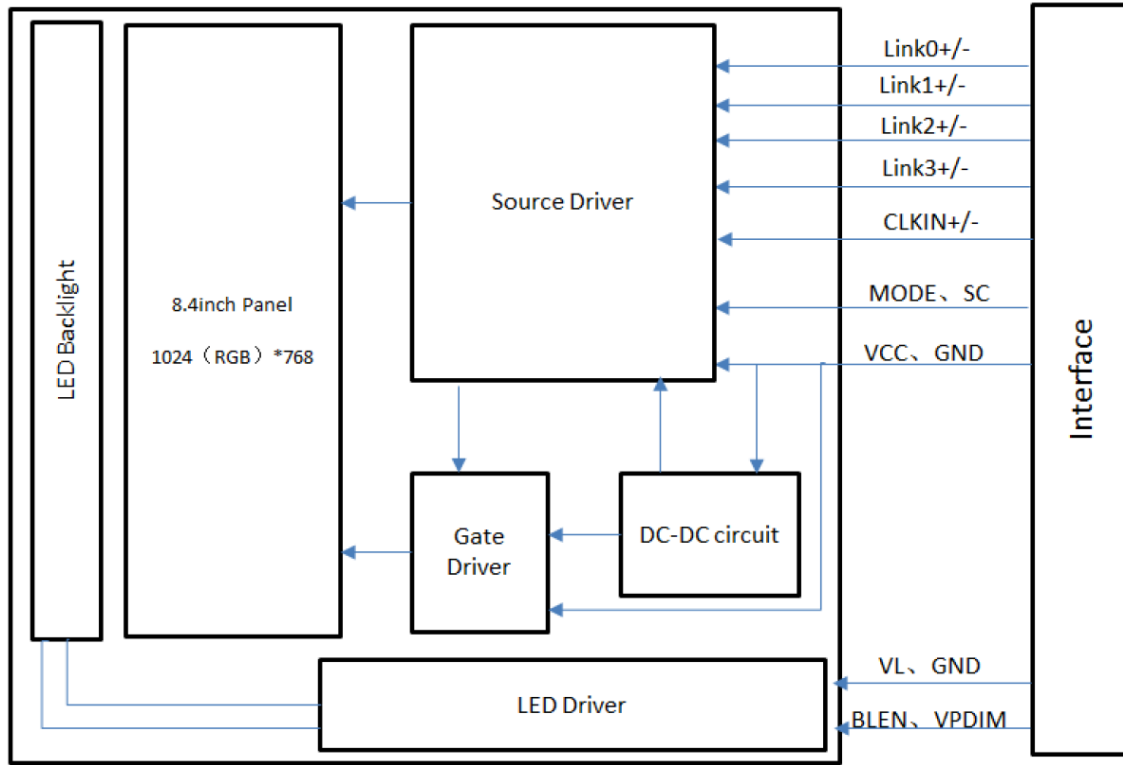

### 4. Absolute Maximum Ratings

Absolute maximum ratings of the module are as following:

#### 4.1 TFT LCD module

Items	Symbol	Min	Max	Unit	Conditions
Power supply voltage	V <sub>DD</sub>	-0.3	5.0	Volt	Note 1, 2

#### 4.2 Backlight unit

Items	Symbol	Min	Max	Unit	Conditions
BLU input current			480	mA	

#### 4.3 Environment

Items	Symbol	Values			Unit	Conditions
		Min.	Typ.	Max.		
Operation temperature	T <sub>OS</sub>	-30	-	80	°C	Note 3
Operation Humidity	H <sub>OP</sub>	10		85	%	
Storage temperature	T <sub>ST</sub>	-40		90	°C	
Storage Humidity	H <sub>ST</sub>	5		90	%	

Note 1: With in Ta= 25°C

Note 2: Permanent damage to the device may occur if exceed maximum values

Note 3: For quality performance, please refer to IIS (Incoming Inspection Standard).

### 5. Electrical characteristics

#### 5.1 TFT LCD module

##### 5.1.1 Power specification

VCC=3.3V, GND=0V, Ta = 25°C

Item	Symbol	MIN	TYP	MAX	Unit	Remark
Power supply voltage	VCC	3.2	3.3	3.4	V	
Power Ground	GND	-	0	-	V	
Input High Voltage	VIH	0.7xVCC		VCC	V	Note1
Input Low Voltage	VIL	GND		0.3xVCC	V	
LVDS differential input high threshold voltage	RxVTH	-	-	+200	mV	Note2
LVDS differential input low threshold voltage	RxVTL	-200	-	-		
Differential input voltage	VID	200	-	600	mV	
Differential input common mode voltage	RxVCM	1.0	1.2	$1.7 \cdot \frac{ VID }{2}$	V	
Current of VCC Power supply	IVCC	-	310	-	mA	Note3
Power consumption	P	-	1023	-	mW	
Inrush current of VCC	Irush	-	TBD	TBD	A	Note4

Note1: Including MODE,SC.

Note2: Refers to the LVDS waveform as shown below

Note3: Test pattern in white

Note4:VCC rising time >1ms.

Single-end Signal

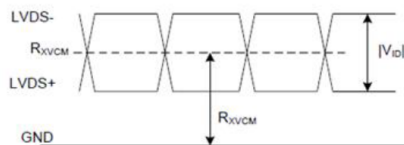

Differential Signal

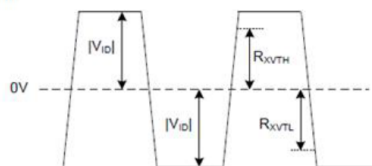

LVDS DC Diagram

## 5.2 Backlight unit

Parameter	Min	Typ	Max	Unit	Note
LED voltage (VL)		27		[V]	2
LED current (IL)		320		[mA]	2
LED power (PL)		8.64		[W]	
LED lite time (MTBF)		100,000		[Hour]	1

Note 1: The "LED lift time" is defined as the module brightness decrease to 50% original brightness that the ambient temperature is 25°C and typical LED Current at 320 mA

Note 2: The variance of LED Light Bar power consumption is ±10%. Calculator value for reference ( $IL \times VL = PLED$ )

### 5.3 Interface connector

#### 5.3.1 TFT connector(CN1)

Matching Connector: FI-SEB20P-HFE

Pin No.	Symbol	I/O	Function	Remark
1	VCC	P	3.3V power supply	-
2	VCC	P	3.3V power supply	-
3	GND	P	Ground	Note2
4	GND	P	Ground	Note2
5	Link0-	I	Negative LVDS differential data input	
6	Link0+	I	Positive LVDS differential data input	
7	GND	P	Ground	Note2
8	Link1-	I	Negative LVDS differential data input	
9	Link1+	I	Positive LVDS differential data input	
10	GND	P	Ground	Note2
11	Link2-	I	Negative LVDS differential data input	
12	Link2+	I	Positive LVDS differential data input	
13	GND	P	Ground	Note2
14	CLKIN-	I	Negative LVDS differential data input	
15	CLKIN+	I	Positive LVDS differential data input	
16	GND	P	Ground	Note2
17	Link3-	I	Negative LVDS differential data input	Note3
18	Link3+	I	Positive LVDS differential data input	Note3
19	MODE	I	6-bit / 8-bit input select for LVDS interface. High : 8bit. Low : 6bit.	
20	SC	I	Reverse Scan control Low : Normal scan High or Open : Reverse scan	Note4

Note1:I---Input, O---Output, P--- Power/Ground

Note2: All of the GND Pins should be connected to the system ground.

Note3: Please set to GND if pin is NOT in use.

Note4: The function of the SC. The figure below is a front view.

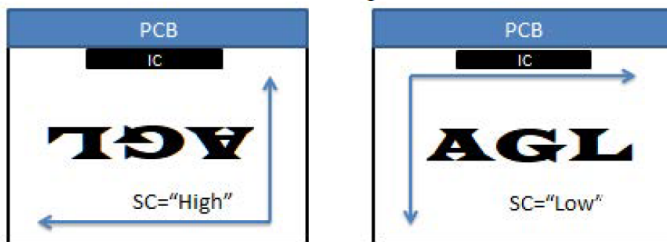

Scanning diagram

## 5.3.2 Backlight connector(CN2)

Recommended connector : BHSR-02VS-1 manufactured by JST

Pin no	Symbol	Description	Note
1	V <sub>LED+</sub>	Backlight LED anode	Red
2	V <sub>LED-</sub>	Backlight LED cathode	Black

## 6. Signal characteristics

### 6.1 LCD panel power ON/OFF sequence

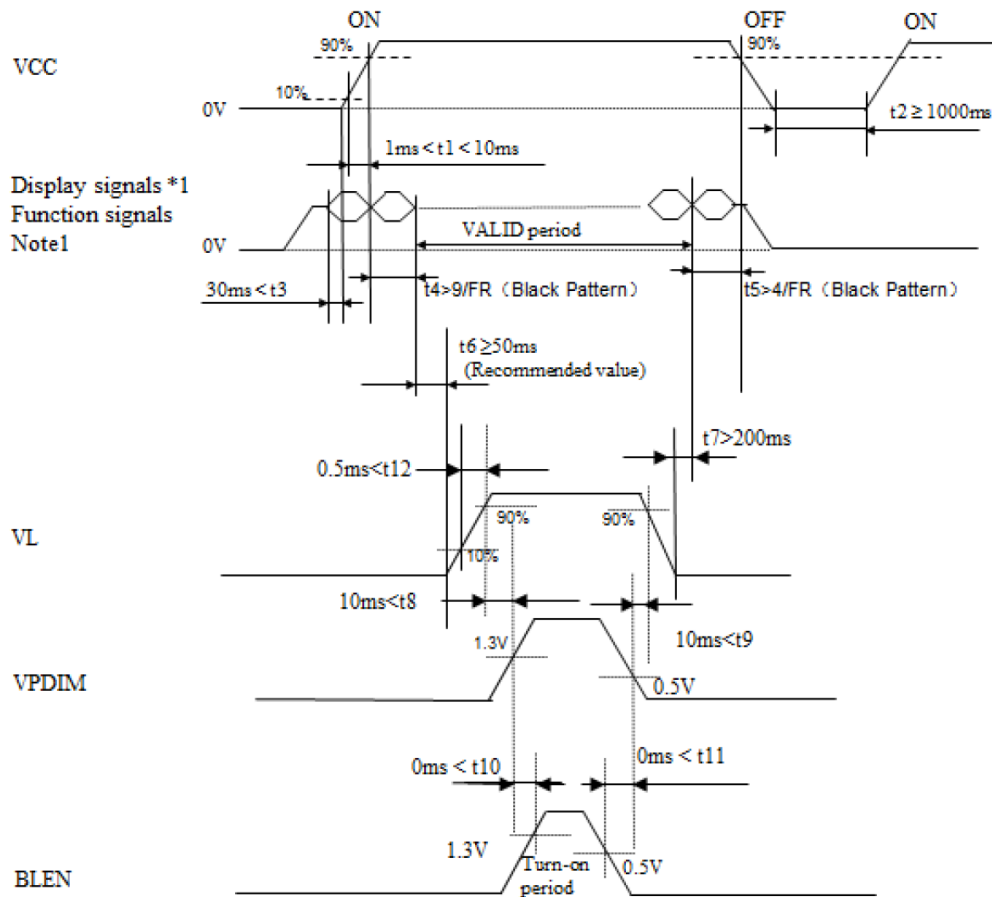

\*1: Link0+/-, Link1+/-, Link 2+/-, Link 3+/-, CLKIN+/-

Figure 4.4 Power ON/OFF sequence

Note1: If some of display and function signals of this product are cut while this product is working, even if the signal input to it once again, it might not work normally. If a customer stops the display and function signals, VCC also must be shut down.

Note2: The backlight should be turned on within the valid period of display and function signals, in order to avoid unstable data display.

Note3: FR=Frame rate=60Hz.



## 7. Timing chart

### 7.1 LVDS interface timing characteristics

#### 7.1.1 LVDS input data format 8-bit LVDS VESA

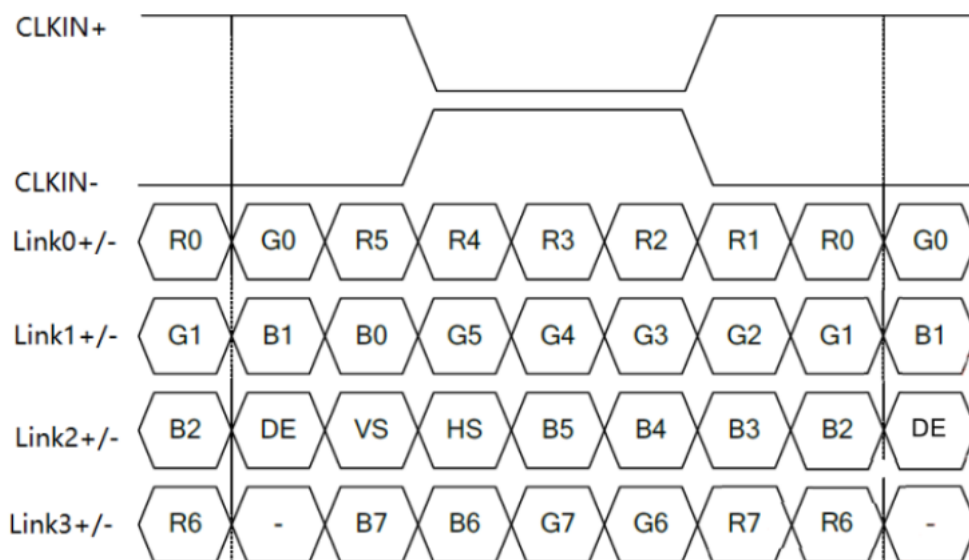

#### 7.1.2 LVDS input data format 6-bit LVDS VESA

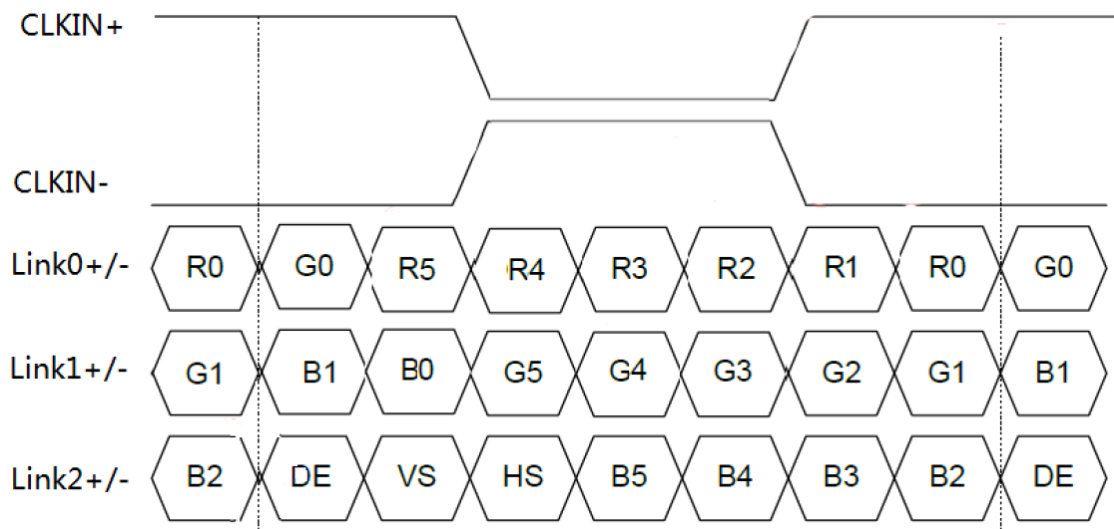

### 7.2 Input timing table

DE mode for 1024RGB\*768

Parameter	Symbol	Min.	Typ.	Max.	Unit
CLKIN+/- frequency	FCLK	50.3	50.7	65.3	MHz
Horizontal display area	THD	1024			CLK
HS period time	TH	1084	1088	1214	CLK
HS blanking	THFP+THBP	60	64	190	CLK
Vertical display area	TVD	768			H
VS period time	TV	774	776	897	H
VS blanking	TVBP+TVFP	6	8	129	H

### 7.3 LVDS input timing format

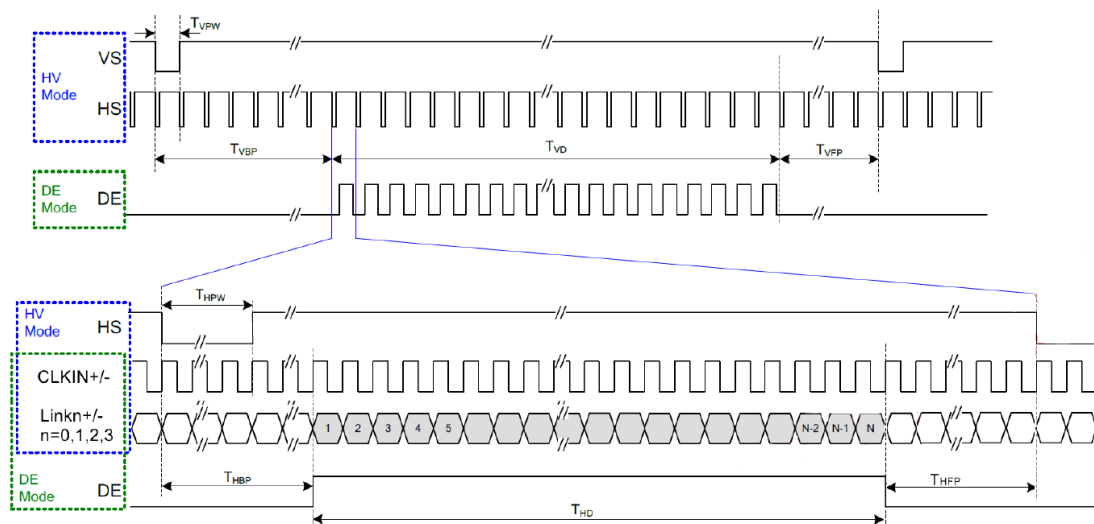

**Recommended input timing of LVDS transmitter**

Note1: As shown in the figure above, the customer only needs to look at the DE mode section, instead of the SYNC section.

### 7.4 LVDS interface AC characteristics

Parameter	Symbol	Min.	Typ.	Max.	Unit	Condition
Clock frequency	FLVCLK	25	-	85	MHz	Refer to input timing table for each display resolution.
Clock Period	TLVCLK	11.76	-	40	nsec	
Clock high time	TLVCH	-	$4/(7 \cdot \text{RXFCLK})$	-	ns	
Clock low time	TLVCL	-	$3/(7 \cdot \text{RXFCLK})$	-	ns	
Input data skew margin	TRSKM	-	-	0.25	UI	VCC_IF=1.8V w/o SSC
Strobe width	TSW	0.5	-	-	UI	
1 data bit time	UI	-	1/7	-	TLVCLK	
Position 1	TPOS1	-0.25	0	0.25	UI	
Position 0	TPOS0	0.75	1	1.25	UI	
Position 6	TPOS6	1.75	2	2.25	UI	
Position 5	TPOS5	2.75	3	3.25	UI	
Position 4	TPOS4	3.75	4	4.25	UI	
Position 3	TPOS3	4.75	5	5.25	UI	
Position 2	TPOS2	5.75	6	6.25	UI	

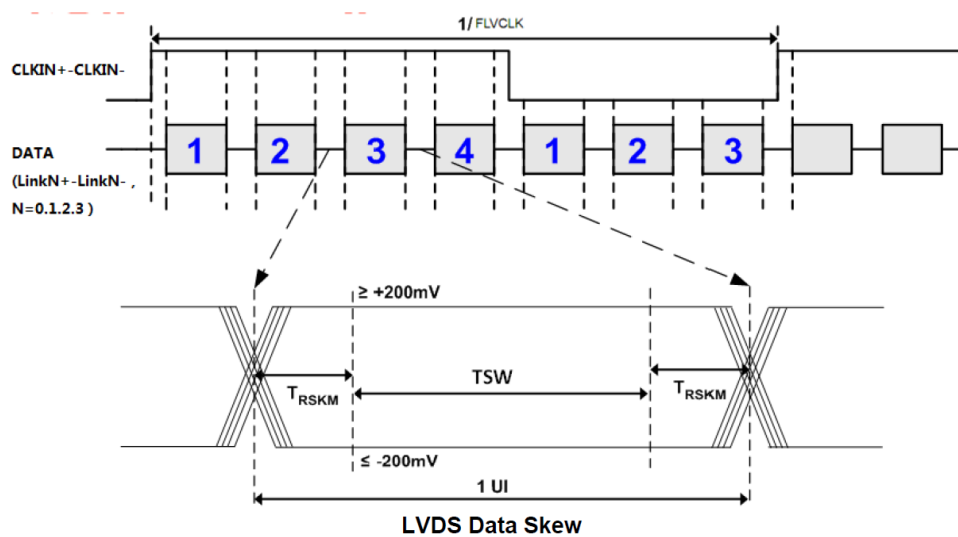

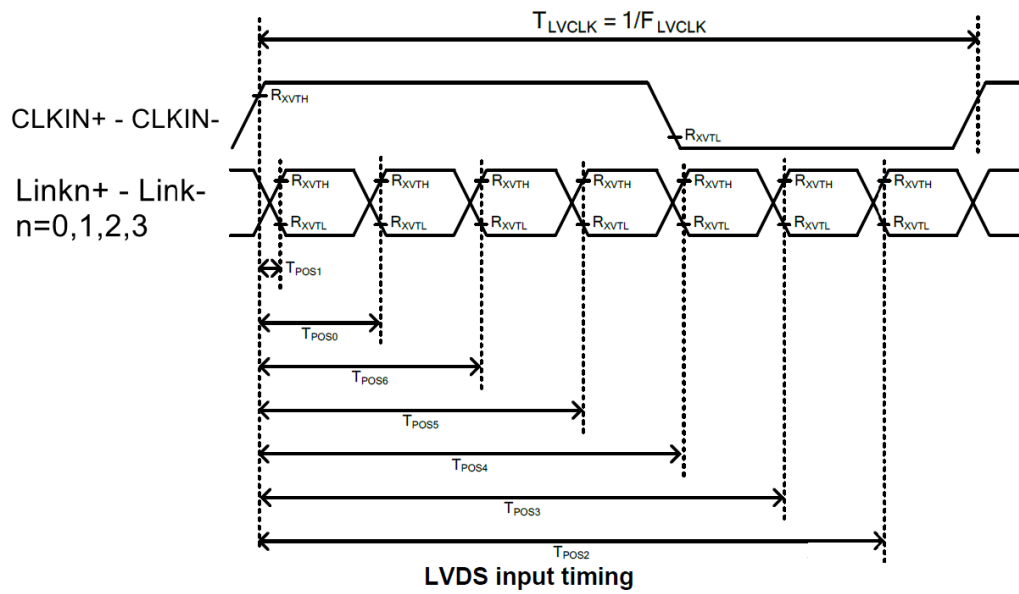

### 8. Reliability Test

Environment test conditions are listed as following table.

Items	Required Condition	Note
Temperature Humidity Bias (THB)	Ta=40°C, 80%RH, 120hours	
High Temperature Operation (HTO)	Ts= 80°C, 120hours	3
Low Temperature Operation (LTO)	Ta= -30°C, 120hours	
High Temperature Storage (HTS)	Ta= 90°C, 120hours	
Low Temperature Storage (LTS)	Ta= -40°C, 120hours	
Thermal Shock Test (TST)	-20°C/30min, 60°C/30min, 100 cycles	
On/Off Test	On/10sec, Off/10sec, 30,000 cycles	
ESD (ElectroStatic Discharge)	Contact Discharge: ± 8KV, 150pF(330Ω ) 1sec/cycle	
	Air Discharge: ± 15KV, 150pF(330Ω ) 1sec/cycle	

Note 1: The TFT-LCD module will not sustain damage after being subjected to 100 cycles of rapid temperature change. A cycle of rapid temperature change consists of varying the temperature from -10°C to 50°C, and back again. Power is not applied during the test. After temperature cycling, the unit is placed in normal room ambient for at least 4 hours before power on.

Note 2: According to EN61000-4-2 , ESD class B: Some performance degradation allowed. No data lost. Self-recoverable. No hardware failures.

Note 3: TFT surface.

Note 4: There should be no condensation on the surface of panel during test.

Note 5: In the standard conditions, there is no function failure issue occurred. All the cosmetic specification is judged before reliability test.

Note 6: Before cosmetic and function test, the product must have enough recovery time, at least 4 hours at room temperature.

### 9. Shipping package (TBD)

No	Item	Model (Material)	Dimensions(mm)	Unit Weight(Kg)	Quantity	Remark
1	LCM module	Panel	173.4×149×9.7	0.301	20	
2	Tray	PET	485×330×25	0.257	12	
3	Dust-proof Bag	PE	700×545×0.05	0.021	1	
4	Carton	Corrugated Paper	544×365×250	1.01	1	
5	BOX	Corrugated Paper	520×345×111	0.38	2	
6	Label		100×52	0.001	1	
7	EPE	EPE	485×330×5	0.016	2	
8	Total weight	10.95Kg ± 5%				

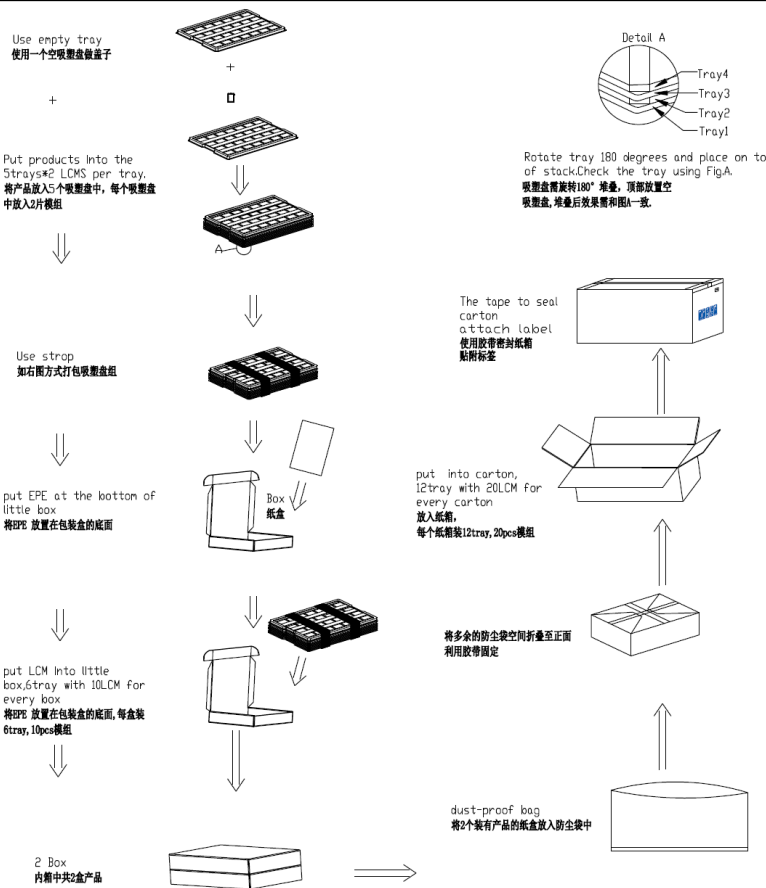

**10. Mechanical Characteristics**

